

Data sheet | Item number: 231-619/114-000

1-conductor male connector; Snap-in flange; 2.5 mm²; Pin spacing 5 mm;
19-pole

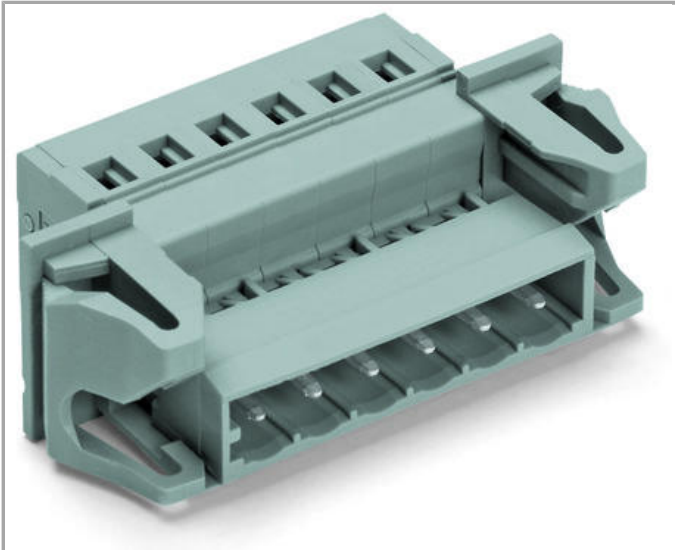

231-619/114-000



RoHS
Compliant

BOMcheck.net

Color: ■

Derating-Kurve

1-Leiter-Federleiste (231-102/026-000) mit

1-Leiter-Stiftleiste (231-602)

Rastermaß 5 mm / Leiterquerschnitt 2,5 mm² „f“

In Anlehnung an: EN 60512-5-2 / Reduktionsfaktor 0,8

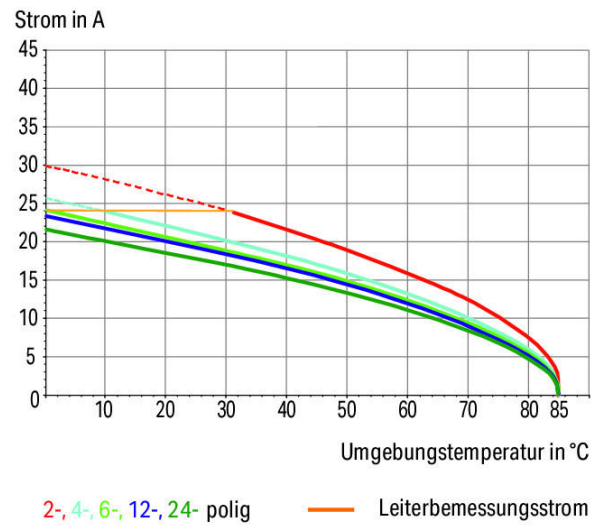

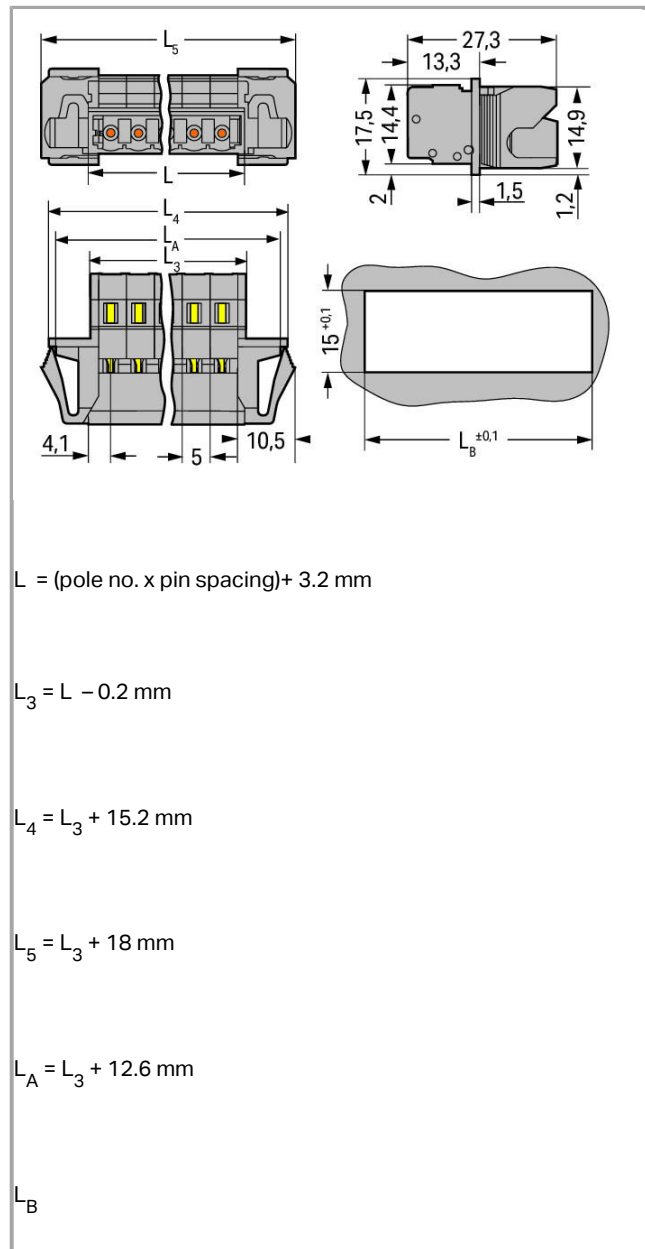
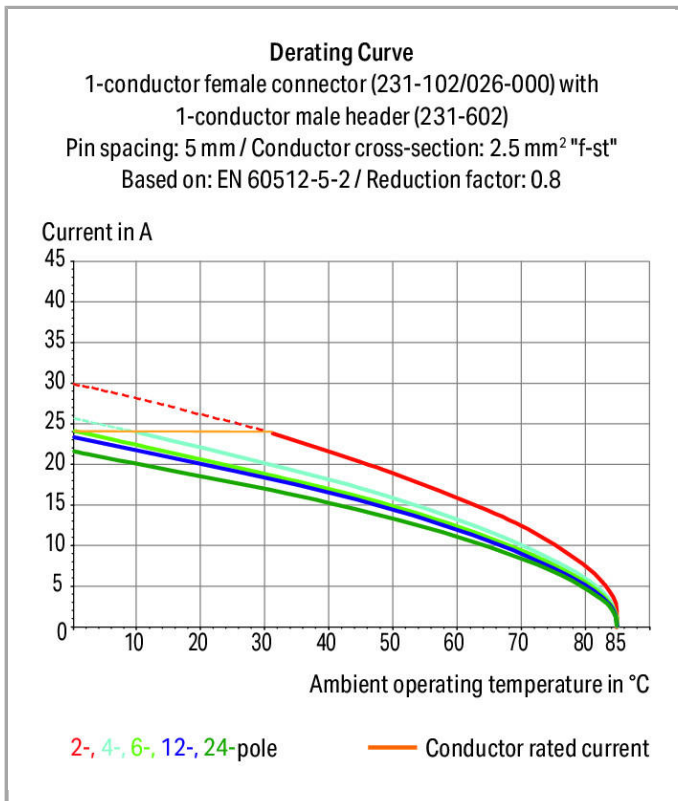

Item description

- Universal connection for all conductor types
- Easy cable pre-assembly and on-unit wiring via vertical and horizontal CAGE CLAMP® actuation
- For wire-to-wire and board-to-wire connections
- Versions available with snap-in mounting feet or flanges for panel or through-panel mounting
- With coding fingers

Safety information 1:



The *MULTI CONNECTION SYSTEM (MCS)* is designed without breaking capacity for compliance with DIN EN 61984. When used as intended, MCS Connectors shall not be connected/disconnected when live or under load. The circuit design should ensure header pins, which can be touched, are not live when unmated.

Data

Electrical data

Ratings per IEC/EN 60664-1

Rated voltage (III / 3)	320 V
Rated impulse voltage (III / 3)	4 kV
Rated voltage (III / 2)	320 V
Rated impulse voltage (III / 2)	4 kV
Rated voltage (II / 2)	630 V
Rated impulse voltage (II / 2)	4 kV
Rated current	12 A

Approvals per UL 1059

Rated voltage UL (Use Group B)	300 V
Rated current UL (Use Group B)	15 A
Rated voltage UL (Use Group D)	300 V
Rated current UL (Use Group D)	10 A

Approvals per UL 1977

Rated voltage per UL 1977 (factory wiring only)	600 V
Rated current per UL 1977 (factory wiring only)	15 A

Approvals per CSA

Rated voltage CSA (Use Group B)	300 V
Rated current CSA (Use Group B)	15 A
Rated voltage CSA (Use Group D)	300 V
Rated current CSA (Use Group D)	10 A

Connection data

Connection technology	CAGE CLAMP®
Actuation type	Operating tool
Solid conductor	0.08 ... 2.5 mm ² / 28 ... 12 AWG
Fine-stranded conductor	0.08 ... 2.5 mm ² / 28 ... 12 AWG
Fine-stranded conductor with ferrule with plastic collar	0.25 ... 1.5 mm ²
Fine-stranded conductor with ferrule without plastic collar	0.25 ... 2.5 mm ²
Strip length	8 ... 9 mm / 0.31 ... 0.35 inch



No. of poles	19
Total number of connection points	19
Total number of potentials	19
Number of connection types	1
Number of levels	1
Conductor entry direction to mating direction	0°

Geometrical Data

Pin spacing	5 mm / 0.197 inch
Width	116 mm / 4.567 inch
Height	17.5 mm / 0.689 inch
Depth	27.5 mm / 1.083 inch

Mechanical data

Gehäuseblechstärke	0.5 ... 2.5 mm / 0.02 ... 0.098 inch
Mounting type	Snap-in
Type of mounting	Feed-through mounting

Plug connection

Contact type (pluggable connector)	Male connector/plug
Connector connection type	for conductors
Mismating protection	No

Material Data

Color	gray
Material group	I
Insulating material	Polyamide 66 (PA 66)
Flammability class per UL94	V0
Clamping spring material	Chrome nickel spring steel (CrNi)
Contact material	Electrolytic copper (E _{Cu})
Contact plating	tin-plated
Fire load	0.556 MJ
Weight	30.37 g

Environmental Requirements

Limit temperature range	-60 ... +100 °C
-------------------------	-----------------

Commercial data

Product Group	3 (Multi Conn. System)
---------------	------------------------



Country of origin	DE
GTIN	4050821216179
Customs Tariff No.	85366990990

Approvals / Certificates



Country specific Approvals

Logo	Approval	Additional Approval Text	Certificate name
	CB DEKRA Certification B.V.	IEC 61984	NL-39756
	CSA DEKRA Certification B.V.	C22.2	1466354

Ship Approvals





Logo	Approval	Additional Approval Text	Certificate name
	ABS American Bureau of Shipping	-	14- HG1241537- PDA
	DNV GL Det Norske Veritas, Germanischer Lloyd	-	TAE000016Z

UL-Approvals

Logo	Approval	Additional Approval Text	Certificate name
	UR UL International Germany GmbH	UL 1977	E45171
	UR UL International Germany GmbH	UL 1977	E45171

Compatible products



Jumper



















	Item no.: 231-902 Comb-style jumper bar; for 5 mm and 5.08 mm pin spacing; reduces conductor size to 1.5 mm	231-902
	Item no.: 231-903 Comb-style jumper bar; 3-way; suitable for 231 Series female connectors; with 5 mm pin spacing; insulated	231-903
	Item no.: 231-905 Comb-style jumper bar; 5-way; suitable for 231 Series female connectors; with 5 mm pin spacing; insulated	231-905
	Item no.: 231-907 Comb-style jumper bar; 7-way; suitable for 231 Series female connectors; with 5 mm pin spacing; insulated	231-907
	Item no.: 231-910 Comb-style jumper bar; 10-way; suitable for 231 Series female connectors; with 5 mm pin spacing; insulated	231-910

















Marking accessories















	Item no.: 210-331/500-103 Marking strips; as a DIN A4 sheet; MARKED; 1-12 (300x); Height of marker strip: 2.3 mm/0.091 in; Strip length 182 mm; Horizontal marking; Self-adhesive	210-331 /500-103
	Item no.: 210-331/500-104 Marking strips; as a DIN A4 sheet; MARKED; 13-24 (300x); Height of marker strip: 2.3 mm/0.091 in; Strip length 182 mm; Horizontal marking; Self-adhesive	210-331 /500-104
	Item no.: 210-332/500-202 Marking strips; as a DIN A4 sheet; MARKED; 1-16 (160x); Height of marker strip: 3 mm; Strip length 182 mm; Horizontal marking; Self-adhesive	210-332 /500-202
	Item no.: 210-332/500-204 Marking strips; as a DIN A4 sheet; MARKED; 17-32 (160x); Height of marker strip: 3 mm; Strip length 182 mm; Horizontal marking; Self-adhesive	210-332 /500-204
	Item no.: 210-332/500-205 Marking strips; as a DIN A4 sheet; MARKED; 1-32 (80x); Height of marker strip: 3 mm; Strip length 182 mm; Horizontal marking; Self-adhesive	210-332 /500-205
	Item no.: 210-332/500-206 Marking strips; as a DIN A4 sheet; MARKED; 33-48 (160x); Height of marker strip: 3 mm; Strip length 182 mm; Horizontal marking; Self-adhesive	210-332 /500-206
	Item no.: 210-833 Marking strips; on reel; 6 mm wide; plain; Self-adhesive	210-833
	Item no.: 210-834 Marking strips; on reel; 5 mm wide; plain; Self-adhesive	210-834

tools

	Item no.: 209-130 Operating tool; suitable for 264, 280 and 281 Series; 1-way; of insulating material	209-130
	Item no.: 209-132 Operating tool; for connecting comb-style jumper bar; 2-way; of insulating material	209-132

	Item no.: 210-250 Operating tool; for female and male connectors with CAGE CLAMP® connection; MCS MIDI & MINI	210-250
	Item no.: 210-657 Operating tool with partially insulated shaft; Blade (3.5 x 0.5) mm; short	210-657
	Item no.: 210-720 Operating tool with partially insulated shaft; Type 2, blade (3.5 x 0.5) mm	210-720
	Item no.: 231-131 Push-button; for female and male connectors; loose	231-131
	Item no.: 231-159 Operating tool; for male and female connectors with CAGE CLAMP®; of Series 231, 232, 721, 722, 723, 731, 732	231-159
	Item no.: 231-231 Combination operating tool; for male and female connectors with CAGE CLAMP®	231-231
	Item no.: 231-291 Operating tool; for male and female connectors with CAGE CLAMP®; loose	231-291
	Item no.: 280-432 Operating tool; of insulating material; 2-way	280-432
	Item no.: 280-433 Operating tool; of insulating material; 3-way	280-433
	Item no.: 280-434 Operating tool; of insulating material; 4-way	280-434
	Item no.: 280-435 Operating tool; of insulating material; 5-way	280-435
	Item no.: 280-436 Operating tool; of insulating material; 6-way	280-436
	Item no.: 280-437 Operating tool; of insulating material; 7-way	280-437
	Item no.: 280-438 Operating tool; of insulating material; 8-way	280-438
	Item no.: 280-440 Operating tool; of insulating material; 10-way	280-440
General accessories		
	Item no.: 231-668 Lockout caps; for covering unused clamping units	231-668
ferrule		
	Item no.: 216-101 Ferrule; Sleeve for 0.5 mm ² / AWG 22; uninsulated; electro-tin plated	216-101
	Item no.: 216-102 Ferrule; Sleeve for 0.75 mm ² / AWG 20; uninsulated; electro-tin plated	216-102
	Item no.: 216-103 Ferrule; Sleeve for 1 mm ² / AWG 18; uninsulated; electro-tin plated	216-103

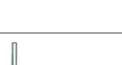
	Item no.: 216-104 Ferrule; Sleeve for 1.5 mm ² / AWG 16; uninsulated; electro-tin plated	216-104
	Item no.: 216-106 Ferrule; Sleeve for 2.5 mm ² / AWG 14; uninsulated; electro-tin plated	216-106
	Item no.: 216-121 Ferrule; Sleeve for 0.5 mm ² / AWG 22; uninsulated; electro-tin plated	216-121
	Item no.: 216-122 Ferrule; Sleeve for 0.75 mm ² / AWG 20; uninsulated; electro-tin plated	216-122
	Item no.: 216-123 Ferrule; Sleeve for 1 mm ² / AWG 18; uninsulated; electro-tin plated	216-123
	Item no.: 216-124 Ferrule; Sleeve for 1.5 mm ² / AWG 16; uninsulated; electro-tin plated	216-124
	Item no.: 216-131 Ferrule; Sleeve for 0.25 mm ² / AWG 24; uninsulated; electro-tin plated	216-131
	Item no.: 216-132 Ferrule; Sleeve for 0.34 mm ² / AWG 24; uninsulated; electro-tin plated	216-132
	Item no.: 216-141 Ferrule; Sleeve for 0.5 mm ² / 20 AWG; uninsulated; electro-tin plated; electrolytic copper; gastight crimped; acc. to DIN 46228, Part 1/08.92	216-141
	Item no.: 216-142 Ferrule; Sleeve for 0.75 mm ² / 18 AWG; uninsulated; electro-tin plated; electrolytic copper; gastight crimped; acc. to DIN 46228, Part 1/08.92	216-142
	Item no.: 216-143 Ferrule; Sleeve for 1 mm ² / AWG 18; uninsulated; electro-tin plated; electrolytic copper; gastight crimped; acc. to DIN 46228, Part 1/08.92	216-143
	Item no.: 216-144 Ferrule; Sleeve for 1.5 mm ² / AWG 16; uninsulated; electro-tin plated; electrolytic copper; gastight crimped; acc. to DIN 46228, Part 1/08.92	216-144
	Item no.: 216-151 Ferrule; Sleeve for 0.25 mm ² / AWG 24; uninsulated; electro-tin plated	216-151
	Item no.: 216-152 Ferrule; Sleeve for 0.34 mm ² / AWG 24; uninsulated; electro-tin plated	216-152
	Item no.: 216-201 Ferrule; Sleeve for 0.5 mm ² / 20 AWG; insulated; electro-tin plated	216-201
	Item no.: 216-202 Ferrule; Sleeve for 0.75 mm ² / 18 AWG; insulated; electro-tin plated	216-202
	Item no.: 216-203 Ferrule; Sleeve for 1 mm ² / AWG 18; insulated; electro-tin plated	216-203
	Item no.: 216-204 Ferrule; Sleeve for 1.5 mm ² / AWG 16; insulated; electro-tin plated	216-204
	Item no.: 216-221 Ferrule; Sleeve for 0.5 mm ² / 20 AWG; insulated; electro-tin plated	216-221
	Item no.: 216-222	

	Ferrule; Sleeve for 0.75 mm ² / 18 AWG; insulated; electro-tin plated	216-222
	Item no.: 216-223 Ferrule; Sleeve for 1 mm ² / AWG 18; insulated; electro-tin plated	216-223
	Item no.: 216-224 Ferrule; Sleeve for 1.5 mm ² / AWG 16; insulated; electro-tin plated	216-224
	Item no.: 216-241 Ferrule; Sleeve for 0.5 mm ² / 20 AWG; insulated; electro-tin plated; electrolytic copper; gastight crimped; acc. to DIN 46228, Part 4/09.90	216-241
	Item no.: 216-242 Ferrule; Sleeve for 0.75 mm ² / 18 AWG; insulated; electro-tin plated; electrolytic copper; gastight crimped; acc. to DIN 46228, Part 4/09.90	216-242
	Item no.: 216-243 Ferrule; Sleeve for 1 mm ² / AWG 18; insulated; electro-tin plated; electrolytic copper; gastight crimped; acc. to DIN 46228, Part 4/09.90	216-243
	Item no.: 216-244 Ferrule; Sleeve for 1.5 mm ² / AWG 16; insulated; electro-tin plated; electrolytic copper; gastight crimped; acc. to DIN 46228, Part 4/09.90	216-244
	Item no.: 216-262 Ferrule; Sleeve for 0.75 mm ² / 18 AWG; insulated; electro-tin plated; electrolytic copper; gastight crimped; acc. to DIN 46228, Part 4/09.90	216-262
	Item no.: 216-263 Ferrule; Sleeve for 1 mm ² / AWG 18; insulated; electro-tin plated; electrolytic copper; gastight crimped; acc. to DIN 46228, Part 4/09.90	216-263
	Item no.: 216-264 Ferrule; Sleeve for 1.5 mm ² / AWG 16; insulated; electro-tin plated; electrolytic copper; gastight crimped; acc. to DIN 46228, Part 4/09.90	216-264
	Item no.: 216-284 Ferrule; Sleeve for 1.5 mm ² / AWG 16; insulated; electro-tin plated; electrolytic copper; gastight crimped; acc. to DIN 46228, Part 4/09.90	216-284
	Item no.: 216-301 Ferrule; Sleeve for 0.25 mm ² / AWG 24; insulated; electro-tin plated	216-301
	Item no.: 216-302 Ferrule; Sleeve for 0.34 mm ² / 22 AWG; insulated; electro-tin plated	216-302
	Item no.: 216-321 Ferrule; Sleeve for 0.25 mm ² / AWG 24; insulated; electro-tin plated	216-321
	Item no.: 216-322 Ferrule; Sleeve for 0.34 mm ² / 22 AWG; insulated; electro-tin plated	216-322
Coding		
	Item no.: 231-129 Coding key; snap-on type	231-129
Insulation stop		
	Item no.: 231-670 Insulation stop; 0.08-0.2 mm ² / 0.2 mm ² "s"	231-670
	Item no.: 231-671 Insulation stop; 0.25 - 0.5 mm ²	231-671



Item no.: 231-672
Insulation stop; 0.75 - 1 mm²

231-672

Downloads

CAD/CAE - Smart Data

CAD data

3D Download 231-619/114-000

URL

Download

Subject to changes.